

## D-Bowl Stainless Steel Sink

Stainless Steel Sinks are the most popular choice for today's kitchen. Stainless steel has long been used in kitchen environments for its clean look and durability. Our sinks are made from 304 grade stainless steel that contains 18% chromium and 8-10% nickel and are guaranteed not to rust.

This makes the steel "stainless" and is the highest quality steel used in kitchen sinks. The brushed finish of our sinks is preferred over our competitors for its ability to hide small scratches than can occur over time. We warranty all sinks to last the lifetime of your home.

# S812

20 1/8" x 17 3/4" x 8 1/4"





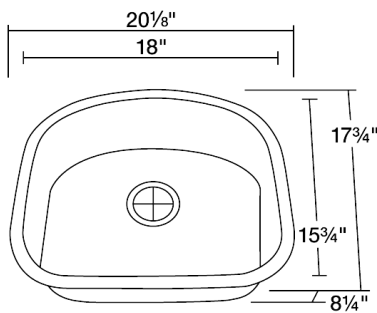



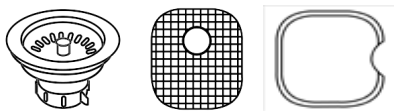



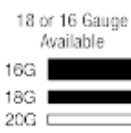

### Dimensions



### Accessories

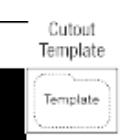

### Features

 Undermount Installation	 21" Minimum Cabinet Size	 18 or 16 Gauge Available 16G 18G 20G	 Cold Rolled Stainless Steel	 Brushed Satin Finish	 Offset Drain 3 1/2"
 Sound Dampening	 Fully Insulated	 Cutout Template	 Hardware Included	 cUPC Certified	 Limited Lifetime Warranty

### Tech Specs

- 16- or 18-Gauge Steel Available
- Certified High-Quality 304 Stainless Steel
- Brushed Satin Finish
- Offset Drain
- Thick Sound Dampener Rubber Pad
- Fully Insulated
- Cardboard Cutout Template Included
- Installation Hardware Included
- Lifetime Warranty