

Rectangular Stainless Steel Utility Sink

Stainless Steel Sinks are the most popular choice for today's kitchen. Stainless steel has long been used in kitchen environments for its clean look and durability. Our sinks are made from 304 grade stainless steel that contains 18% chromium and 8-10% nickel and are guaranteed not to rust.

This makes the steel "stainless" and is the highest quality steel used in kitchen sinks. The brushed finish of our sinks is preferred over our competitors for its ability to hide small scratches than can occur over time. We warranty all sinks to last the lifetime of your home.

Dimensions

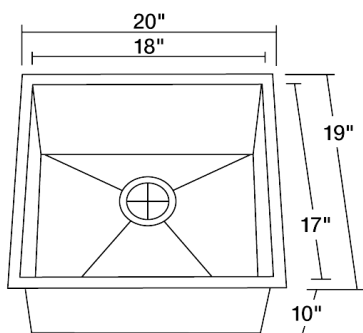

Accessories

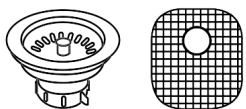









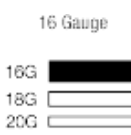

SS1232

20" x 19" x 10"

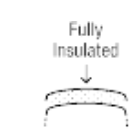
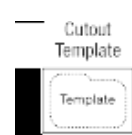

Features

 Undermount Installation	 21" Minimum Cabinet Size	 16 Gauge	 Brushed Satin Finish	 Offset Drain 3 1/2"	 Sound Dampening
 Fully Insulated	 Cutout Template	 Hardware Included	 cUPC Certified	 Limited Lifetime Warranty	

Tech Specs

- 16-Gauge Steel
- Certified High-Quality 304 Stainless Steel
- Brushed Satin Finish
- Offset Drain
- Thick Sound Dampener Rubber Pad
- Fully Insulated
- Cardboard Cutout Template Included
- Installation Hardware Included
- cUPC Certified (Uniform Plumbing Code)
- Lifetime Warranty